

Hyper-bb

Spectral Backscattering Instrument

User's Manual

Version 1.22

June 2021

**Store Software
USB Card Here**



2700 Richards Road, Suite 107
Bellevue, WA 98005-4200
Tel: +1 (855) 753-3313

This page intentionally blank

Hyper-bb Spectral Scattering Instrument

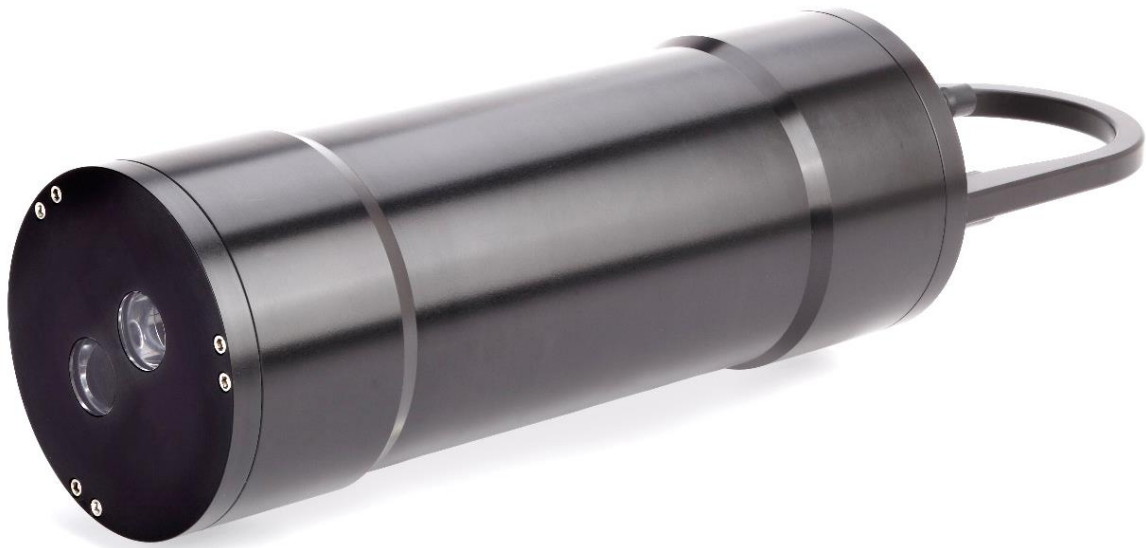

Sequoia Scientific, Inc. contact information:

Telephone: +1 (855) 753-3313

Email: support@sequoiasci.com

Technical assistance

For technical assistance please contact your local Distributor or Sequoia.

Please be sure to include the instrument serial number with any correspondence.

This page intentionally blank

Table of Contents

- 1. Hyper-bb General Description..... 1**
- 2. Quick Start Tutorial 3**
- 3. Data Processing (MatLab) 10**
- Appendix A: Technical Specifications..... 12**
- Appendix B: Hyper-bb Command Summary 14**
- Appendix C: Data File Formats 16**
- Appendix D: Using the Battery Housing..... 17**
- Appendix E: Connector Pinouts..... 20**
- Appendix F: Automated Calibration 23**
- Revision History 28**

1. Hyper-bb General Description

Instrument Description

Hyper-bb measures spectral backscattering at wavelengths from 430 to 700 nm. It produces a collimated beam of light whose center wavelength is controlled by a variable filter under software control. A highly sensitive receiver, based on a photomultiplier, receives light scattered at a center angle of approximately 135 degrees. The receiver has dynamically-adjustable sensitivity, to accommodate a very wide range of signals. Rapid modulation of the LED light source, paired with synchronous detection by the receiver, allows it to detect backscattering even in the presence of strong background light. A microprocessor controls all the instrument functions.

Data Storage and Interface

Data collected with the Hyper-bb is saved onboard the instrument. The data logger stores the data in non-volatile microSD memory which can be later downloaded via the Hyper-bb software. **Always use the Hyper-bb software to offload the data, never open the case to access the SD Card.**

The Hyper-bb communicates via RS232. The supplied power and communications cable has a built in RS232 to USB adaptor. The Hyper-bb software will automatically connect to the instrument, however, you may communicate with the instrument using any serial terminal program (e.g. HyperTerminal, PuTTY, RealTerm). Communication is at 9600 baud.

Depth and Temperature

In addition to measuring spectral backscattering, the Hyper-bb also has depth and temperature sensors. The depth sensor has a 1000 psi full-scale range. The stainless-steel fitting on the Connector endcap is used for testing this sensor, and keeps contamination such as salt and sediment out of the pressure sensor. The temperature is measured using a high precision thermistor imbedded into a stainless-steel probe on the Connector end cap. Both values are stored automatically in the Hyper-bb data file.

Power

The Hyper-bb does not contain internal batteries (except a small cell to maintain the real-time clock), but can be powered from external battery packs (optional accessory) or an external instrument such as a CTD.

For laboratory or tethered usage, power can be supplied through the communications connector on the endcap. Cables up to 50 meters can be provided power and communication with the instrument for real-time observation of the spectral backscattering.

**Included
Accessories**

The instrument is shipped pre-configured and tested. Additionally, a communication cable is supplied so that a user need only provide a computer running Windows.

Software is provided to communicate with the instrument, view real time data, and offload files.

2. Quick Start Tutorial



This section gives step by step instructions to unpack your Hyper-bb, load software, and acquire data in the lab.

Contents of Shipping Case

Let's assume that you are opening the Hyper-bb shipping case for the first time. Inside you will find the following:

- User's Manual,
- USB memory card (credit card size) with the software,
- Hyper-bb instrument,
- Plastic Instrument stands,
- USB Communications cable,
- AC power adapter,
- Insulated stainless steel clamps,
- (Optional) Battery Pack with alkaline batteries installed, and cable.



Step 1: Remove Instrument from Shipping Case.

Start by removing the white plastic instrument stands and set them on a flat working surface. Remove the Hyper-bb from the case and set it on the stands. The Hyper-bb has two distinct ends that we will refer to as the Optics endcap and the Connector endcap.

Optics Endcap

The optics endcap contains the optical windows that the light beam and scattered light passes through to make a measurement. The internal optics and light source electronics are mounted to the inside of this endcap.



Connector Endcap

The connector endcap has a 5-pin underwater connector used for communication and external power. It also has a 6-pin connector that is reserved for future use.

See Appendix E for a full description of the wiring of the underwater connectors and mating cables.

The temperature sensor is located between 6-pin connector and the zinc anode. In the center of the endcap is an LED that blinks to indicate the instrument state. The stainless steel fitting with small tube is the port for the depth sensor.

Also on the Connector endcap is a white plastic lever. This mechanical lever has a strong magnet embedded in the plastic. This magnet can be used to trigger a digital switch inside the instrument which can be used to start and stop the Hyper-bb sampling.

The final item on the endcap is the zinc anode. The sacrificial zinc anode protects the instrument from corrosion during long periods of time in salt water.

Step 2: Check for Clean Windows

Check the optical windows to make sure that they are clean. There are two windows: transmit and receive. Both need to be very clean in order to get good measurements.

The best way to check the windows is by using a flashlight. By shining light from one side and viewing from the other the surface of the windows can be easily checked for cleanliness.

If there is dirt or fingerprints on the windows clean them first by rinsing them with lukewarm water and a mild soap solution (e.g. mild hand soap, liquid dish soap) and then rinsing off all soap residue with clean, particle free water such as deionized water, distilled water or bottled drinking water. The windows can also be wiped clean with a soft cloth (e.g. a lens cloth). **DO NOT use any abrasive. DO NOT use any strong solvent such as acetone or toluene.** The windows are plastic. Treat the windows as you would an expensive camera lens.

Step 3: Attach Communication and Power Cable

Remove the Communications cable from the plastic accessory case within the shipping case. It is the short cable with the USB connector on one end and the 5-pin underwater connector on the other. Remove the underwater cap from the Communications connector. The connectors will all look similar when the protective cap is installed. After removing the cap install the cable making sure that proper alignment of the cable is maintained, so that the connector pins are not bent. Plug the USB cable into the computer. Please note that USB drivers may automatically install the first time the USB cable is plugged into the computer.

Plug in the AC power adapter and connect the barrel plug into the box in the middle of the power and communications cable.

Step 4: Install Hyper-bb Software

At this point the instrument is ready to go. We now need to install the Hyper-bb software. A USB memory card the size of a credit card is included with each instrument. Insert the memory card into a USB port on your PC to install the software. You must install the software on a computer running Windows 7 or later (it is not compatible with Mac or Linux operating systems).

On the memory card you will find the 'Hyper-bb_Installer.exe.' Double click the installer executable to begin installing the software. Follow the onscreen instructions and the installer will transfer the necessary files to your computer and place a shortcut on your desktop and start menu. Do not remove the memory card from your computer until the installation is fully completed.

Step 6: Establish Communication

Ensure the instrument is connected to the computer and supplied with power. The green LED on the instrument endcap should flash green every 5 seconds. If the endcap LED does not flash green, the instrument does not have power.

with the Hyper-bb

Open the Hyper-bb software by double clicking the shortcut on your desktop.

The software will automatically search the COM ports on your computer and establish serial communications with the instrument. Immediately after a connection is established, the software will query the instrument for the list of files saved onboard.

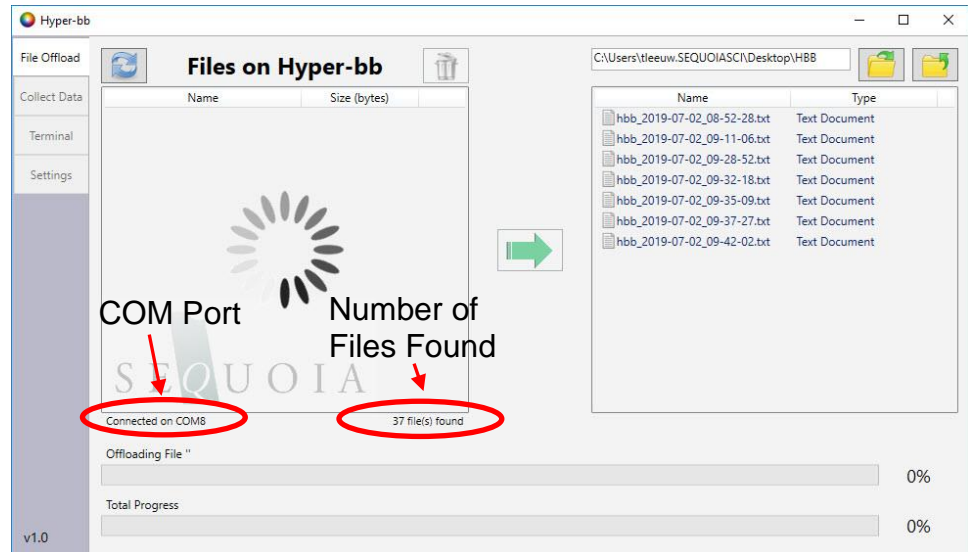

If the software is unable to find the instrument, recheck the power and USB connections. It is also possible the drivers were not installed correctly. Try installing them manually by going back to the USB card and running 'CDM USB Driver.exe'.

Step 7: Offload Files

You may not have collected any data files yet, however, the first screen in the software allows you to offload or delete data files saved onboard the Hyper-bb.

To offload files, select an offload directory on the right side of the screen. Then select one or more files on the left side (stored internally on the Hyper-bb) and press of the green offload button. The files will be offloaded to your chosen directory.

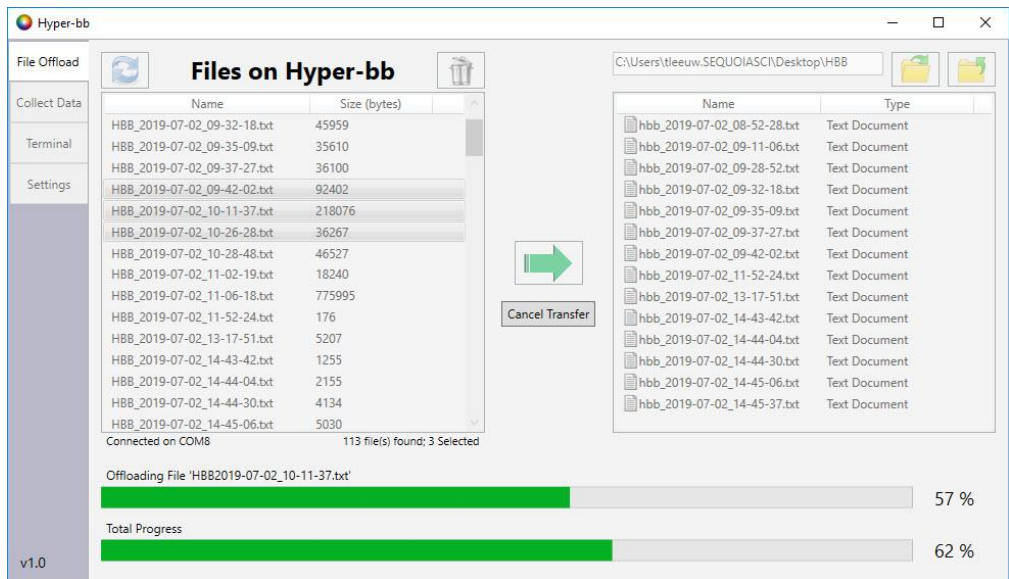

Files can also be deleted by selecting one or more files and pressing the trashcan icon.

Step 8: Viewing Real Time Data

The second tab of the software allows you to view raw data from the instrument in real time.

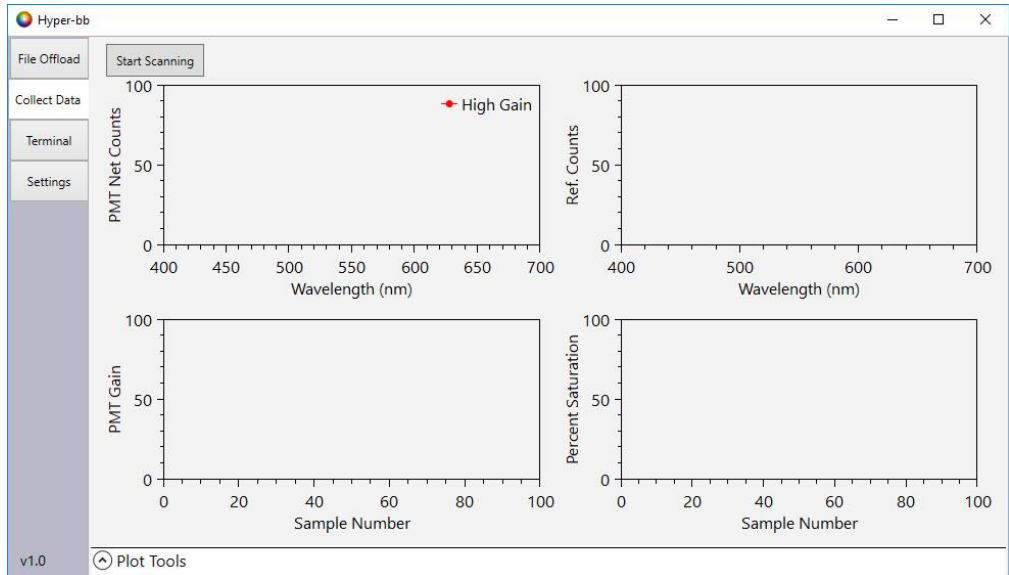

The 'Start Scanning' button will trigger the instrument to start collecting data. The PMT counts, LED reference counts, PMT Gain, and percent saturation will be displayed in real time. The data displayed on the screen will be saved onboard the instrument in the data file shown in the upper right. Data collection will continue until the 'STOP' button is pressed.

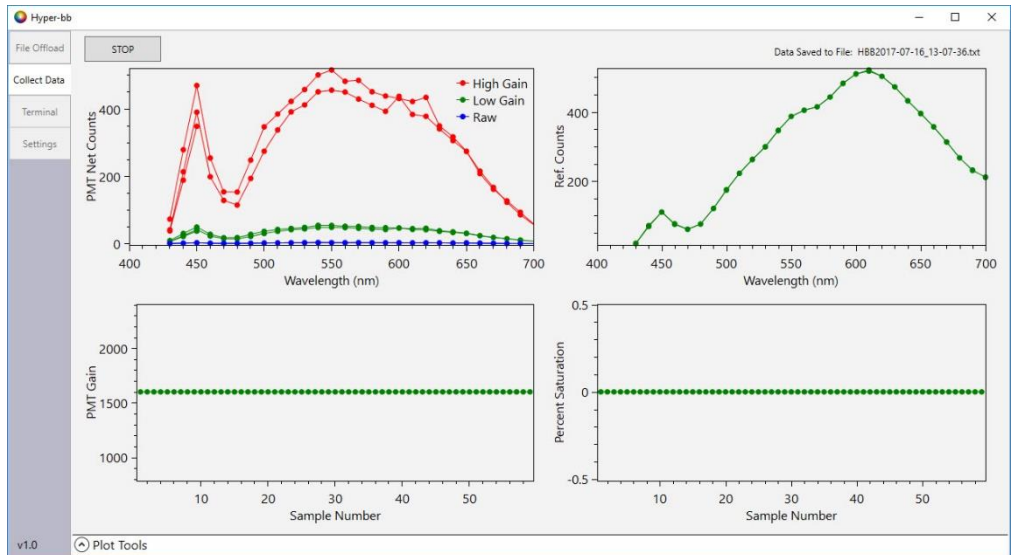

The 'Plot Tools' page can be expanded by clicking on the up arrow at the bottom of the page. The plot tools page allows you to customize what is shown on the plots and how they are scaled.

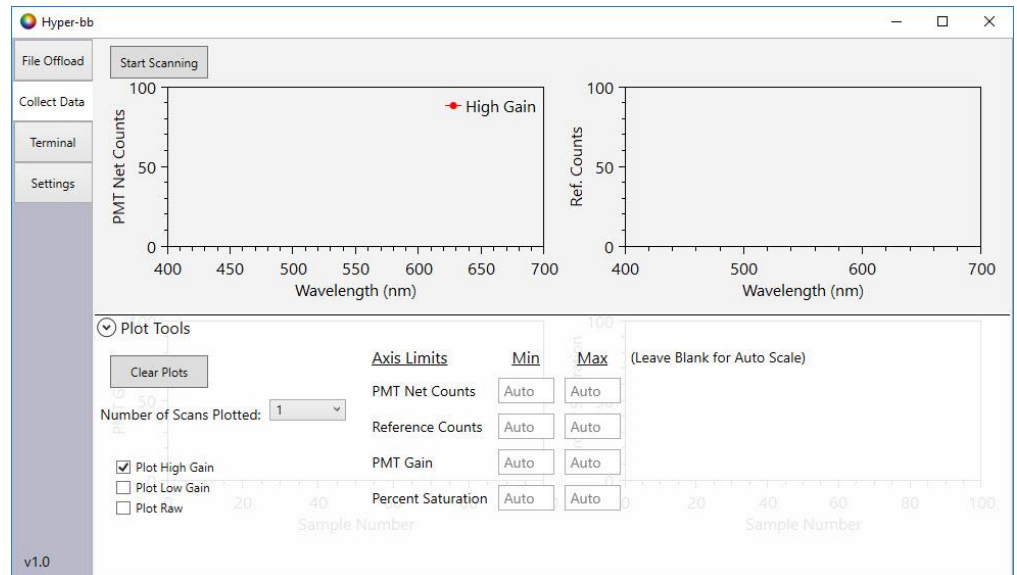

Step 9: Terminal Communication and Instrument Configuration

The third tab of the software opens a terminal window where commands can be directly sent to the instrument. This can be used to configure and control to the instrument. When the window is first opened, the 'help' command is automatically sent to the instrument and a list of available commands is displayed.

Additional options for formatting and logging are available under the 'File' and 'Format' menus.

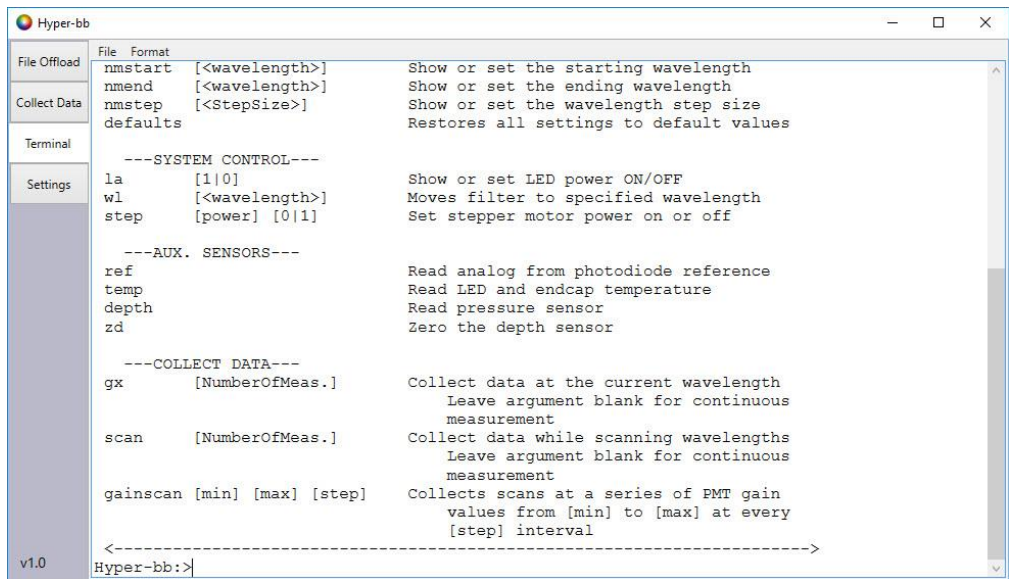

Auto Start

Auto start is used to configure the instrument to start sampling as soon as power is applied. The command ‘autostart’ followed by a ‘1’ or ‘0’ will turn auto start on or off.

Wavelength Configuration

The beginning wavelength, ending wavelength, and wavelength step size are configured using three commands:

‘nmstart <starting wavelength>’

‘nmend <ending wavelength>’

‘nmstep <wavelength step size>’

Use these commands to adjust the scanning range of the Hyper-bb. NOTE: the minimum and maximum wavelengths are 430nm and 700nm.

Additional Commands/Configurations

See the output of the ‘help’ command or Appendix B for additional commands used to configure the instrument and display data.

3. Data Processing (MatLab)

Three MATLAB functions are provided for processing Hyper-bb data and calibrations:

- **Hbb_ReadFile:** Reads in Hyper-bb raw data files (.txt) that are downloaded directly from the instrument.
- **Hbb_ReadCal:** Reads in calibration files generated using the Hyper-bb calibration tank and Hyper-bb windows software. Outputs a .mat file that can be used to process Hyper-bb data.
- **Hbb_Process:** Reads in data and calibration files and computes Beta. The finished results are in a MATLAB table containing both the raw and processed data.

The following shows example data processing MATLAB code.

```
dat = Hbb_Process(datafile, cal_plaque, cal_temp)
```

The first argument 'datafile' is a Hyper-bb data files (.txt files), 'cal_plaque' is a plaque calibration .mat file (Hbb_Cal_Plaque_[date]_[time].mat), and 'cal_temp' is a temperature calibration .mat file (Hbb_Cal_Temp_[date]_[time].mat).

A plaque calibration file will be provided with the instrument. However, if a calibration tank is purchased with the instrument, you can generate new calibration files at any time.

A temperature calibration file will also be provided with instrument. This calibration does not need to be repeated. The temperature calibration supplied with instrument should be used for all data processing.

The output table 'dat' contains all the raw and processed results. Each column includes a header describing the data.

Appendix A: Technical Specifications

- Parameters measured/derived:
 - Spectral Backscattering
 - Depth
 - Temperature
- Data storage memory: 4GB
- Temperature sensor
 - Range: -5 to 45 °C
 - Resolution: 0.001 °C
 - Uncertainty: approximately 1 °C
- Depth Sensor
 - Range: 0 to 600 m of sea water
 - Resolution: 1 cm
 - Uncertainty: approximately 1% of reading (if atmospheric offset zeroed)
- Input power:
 - Operating range: 9 to 24 V
 - Current during active sampling: 750 mA @ 12V
 - Current while waiting for use command: 200 mA @ 12V
- Weight in air: 6.0 kg (13.3 lbs.)
- Weight in water: 1.2 kg (2.6 lbs.)
- Depth rating: 600 m

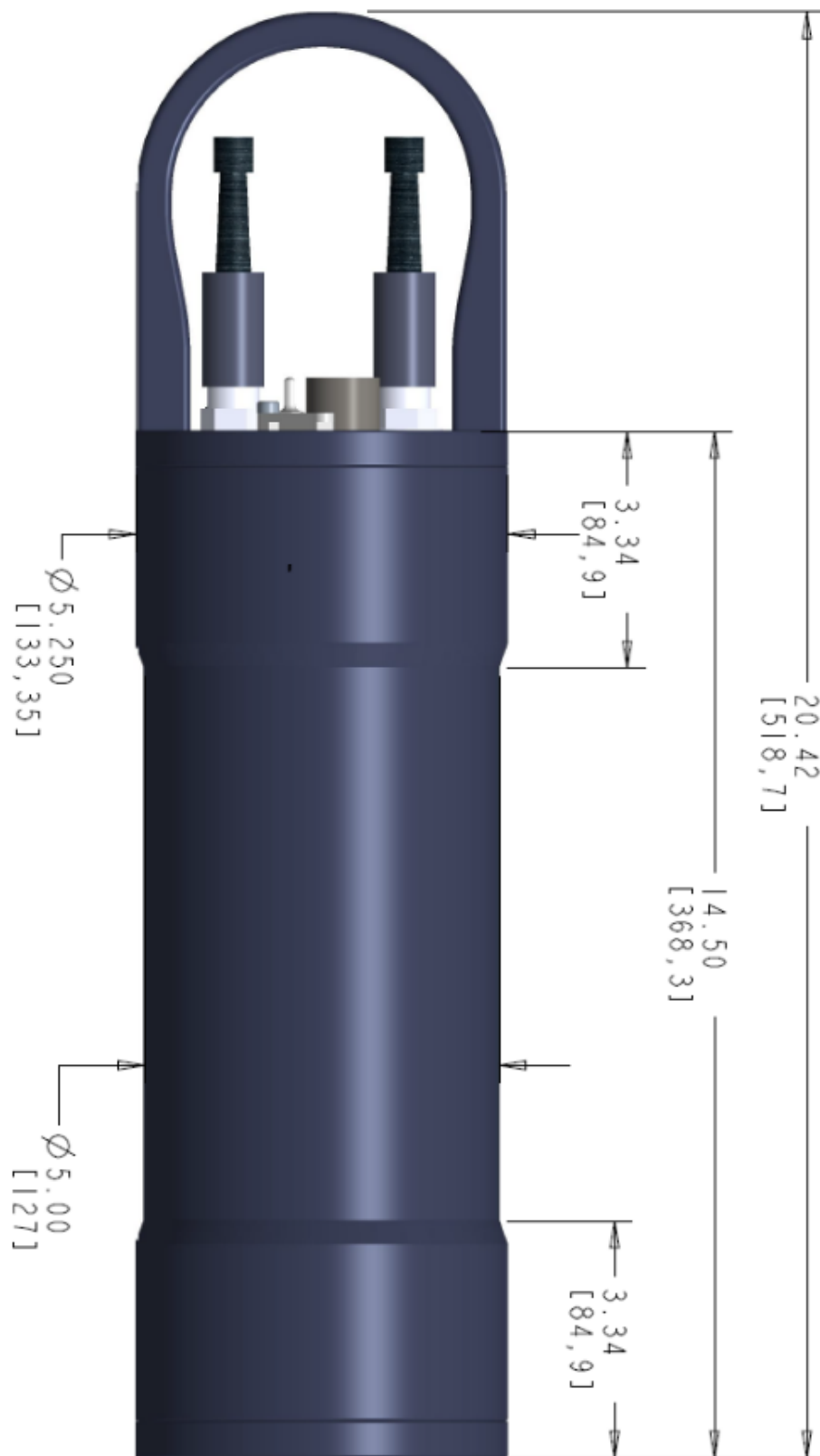

Appendix B: Hyper-bb Command Summary

NOTE: Command are shown in upper case for clarity, but are not case-sensitive.

General Commands

COMMAND	ARGUMENTS	DESCRIPTION
DATE, TIME	[yyyy/mm/dd hh:mm:ss]	Show or set the date and time
DD, LS		Display a list of saved data files
DL	[<filename>]	Delete file
DS		Display current instrument status information
HELP		Display a list of commands
PRINT	[<filename>]	Print file contents to the terminal

Setup Commands

COMMAND	ARGUMENTS	DESCRIPTION
PMT	[<gain>]	Display or set PMT gain value
LEDPOWER	[<power>]	Sets LED output power (0-255)
AUTOGAIN	[0 1]	Turns on/off autogain
AUTOSTART	[0 1]	Turns on/off autostart
NMSTART	[<wavelength>]	Display or set the starting wavelength in nanometers
NMEND	[<wavelength>]	Display or set the ending wavelength in nanometers
NMSTEP	[<StepSize>]	Display or set the wavelength step size in nanometers
DEFAULTS		Restore all settings to default values

Acquisition/Action Commands

COMMAND	ARGUMENTS	DESCRIPTION
LA	[1 0]	Turn LED on/off
WL	[<wavelength>]	Move to specified wavelength
STEP	power [0 1]	Turn on/off stepper motor power
REF		Read LED reference detector
TEMP		Read LED and water temperature
DEPTH		Read depth sensor
ZD		Zero the depth sensor
GX	[Number Of Meas.]	Collect data at the current wavelength. Leave argument blank for continuous measurement
SCAN	[Number Of Meas.]	Collect data while scanning wavelengths. Leave argument blank for continuous measurement
GAINSCAN	[min] [max] [step] [Num. Meas.]	Collects scans at a series of PMT gain values from [min] to [max] at every [step] interval. Optional argument for the number of complete gain scans to collect. Leave argument blank for continuous measurements.
VIN		Read and display supply voltage

Appendix C: Data File Formats

ASCII Raw Data Format The values in the raw ASCII data file (.TXT extension) are stored in the order shown below. Each sample is stored in one row.

Column #	Parameter
1	Scan Number
2	Sample Number
3	Date
4	Time
5	Stepper Position
6	Wavelength (nm)
7	LED Power
8	PMT Gain
9	Net PMT Signal
10	Gain 1 – LED ON – Mean
11	Gain 1 – LED ON – Standard Deviation
12	LED Reference – LED ON – Mean
13	LED Reference – LED ON – Standard Deviation
14	Gain 1 – LED OFF – Mean
15	Gain 1 – LED OFF – Stand Deviation
16	LED Reference – LED OFF – Mean
17	LED Reference – LED OFF – Standard Deviation
18	Gain 2 – LED ON – Mean
19	Gain 2 – LED ON – Standard Deviation
20	Gain 3 – LED ON – Mean
21	Gain 3 – LED ON – Standard Deviation
22	Gain 2 – LED OFF – Mean
23	Gain 2 – LED OFF – Standard Deviation
24	Gain 3 – LED OFF – Mean
25	Gain 3 – LED OFF – Standard Deviation
26	LED Temperature (C)
27	Water Temperature (C)
28	Depth (m)
29	Saturation Percent (%)
30	Calibration Plaque Distance (if applicable)

Appendix D: Using the Battery Housing

The optional External Battery Housing is used to provide power to the Hyper-bb for long term deployments or extended profiling operations.

STEP	ACTION	RESULT
1	<ul style="list-style-type: none">• The Hyper-bb Large External Battery is shipped with 16 Alkaline D batteries pre-installed and is ready for use. The following steps describe how to open the battery and replace the batteries. Skip to Step X to connect the battery to the Hyper-bb.• The new alkaline batteries can be left in the battery housing for storage. However, it is not recommended that fully discharged batteries be left in the battery housing during long term storage.	Battery ready to use when shipped.
2	<ul style="list-style-type: none">• To access and replace the batteries in the Large Battery pack you will need remove the endcap with the connectors and handle.  <ul style="list-style-type: none">• Remove the four 6-32 X ¾ long socket head cap screws from the connector endcap using the provided 7/64" ball driver. Remove the screws uniformly or hold the cap down against the light spring force.	Endcap ready for removal

<p>3</p>	<ul style="list-style-type: none"> • Pull out the connector endcap. There are no wires or other connections. Set the endcap to the side.  <ul style="list-style-type: none"> • Remove the batteries making note of their orientation. • Insert the batteries into the pressure case. Labels on the inside surface of the center divider will guide you on the correct orientation of the batteries for each stack. 	<p>Endcap removed and batteries replaced.</p>
<p>4</p>	<ul style="list-style-type: none"> • Inspect the O-ring on the endcap and the seating surface on the pressure case to make sure there is no debris that could affect the seal. Lightly grease the surfaces as needed. • Align the tab in the center of the endcap to the slot in the post in the center of the pressure case 	<p>Endcap re-installed</p>
<p>5</p>	<ul style="list-style-type: none"> • Screw the connector endcap onto the pressure case with the four 6-32 x 3/4 socket head cap screws. If necessary, apply anti-seize compound onto the threads. 	<p>Battery assembled and ready for use.</p>
<p>6</p>	<ul style="list-style-type: none"> • The battery pack can be connected to the Hyper-bb using the provided 5-pin Male to 5-pin Female cable. • Connect the Male end of the cable to the Female Bulkhead connector on the Large Battery Pack. The connector will be labeled with "TO LISST". 	

6

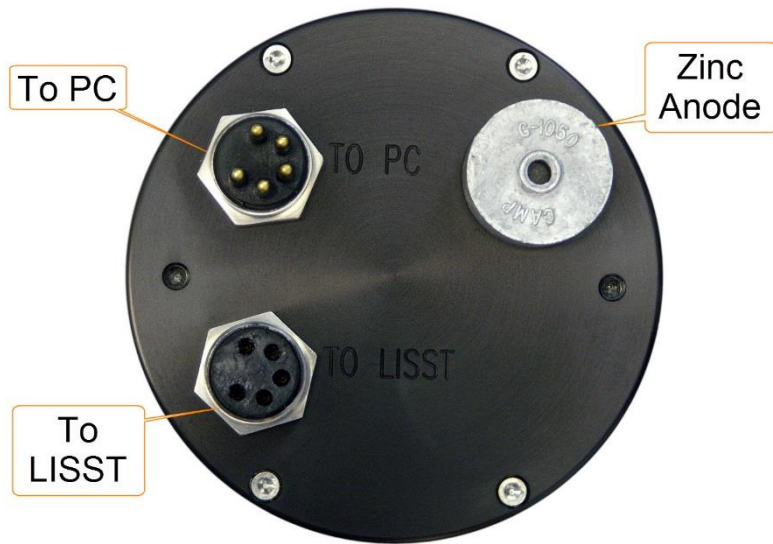

Instrument is powered and ready to collect data

- Connect the other end of the cable to the 5-pin Male bulkhead on the Hyper-bb.
- Power is now going to the Hyper-bb.

7

- If desired, connect the Communications cable to the male 5-pin bulkhead connector on the Large Battery Pack which is labeled “TO PC”. Communications will pass through the battery to the Hyper-bb.
- The battery and communications cables are shown below.



Appendix E: Connector Pinouts

The Hyper-bb has 2 connectors, 5-pin and 6-pin, but presently the 6-pin connector is not used. The photograph shows the placement of each connector

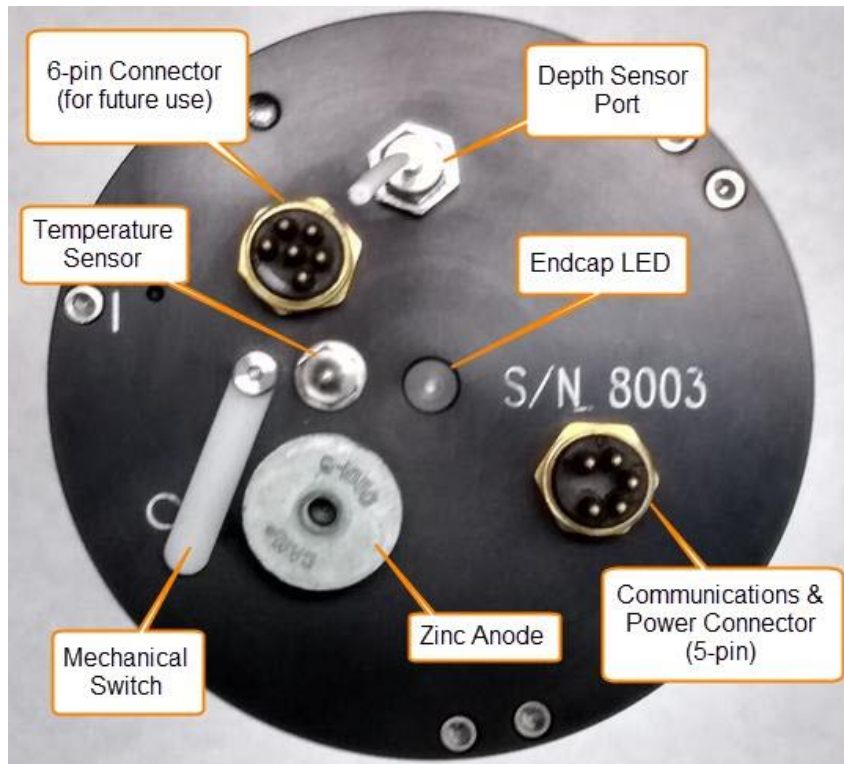

Hyper-bb Connector Endcap

Communications and Power Connector (5 pin connector)

Bulkhead connector: SubConn MCBH5M

Mating cable connector: SubConn MCIL5F



Bulkhead Endview



Cable Endview

Connector Pin #	Use
1	Power/Serial Ground
2	External Power In (+9V nom. 6-15V)
3	Power/Serial Ground
4	Serial Out (to DB-9 Pin 2)
5	Serial In (to DB-9 Pin 3)

External Battery Connectors (5pin and 6 pin connectors)

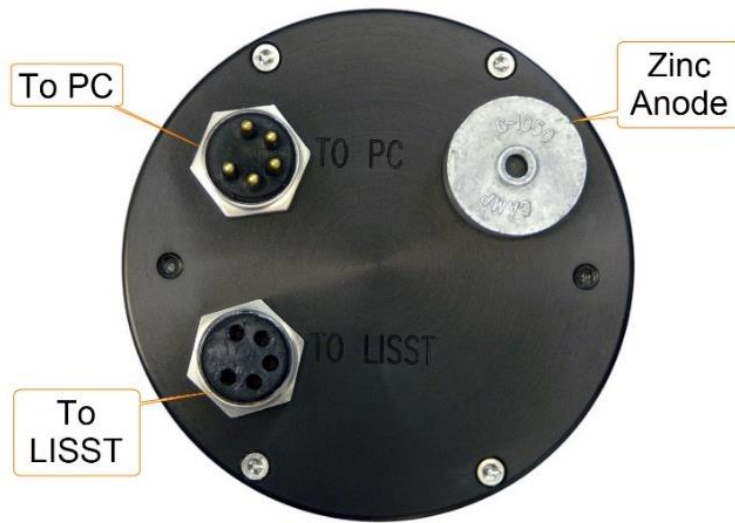

Bulkhead connector: SubConn MCBH5F
Mating Cable Part Number: SubConn MCIL5M



Bulkhead Endview



Cable Endview

To LISST Connector (5-pin Female Bulkhead)

Connector Pin #	Use
1	Ground
2	Battery Power Out (+9 to 24V)
3	Ground
4	Serial Out (to DB-9 Pin 2)
5	Serial In (to DB-9 Pin 3)



Bulkhead Endview



Cable Endview

To PC Connector (5-pin Male Bulkhead)

Connector Pin #	Use
1	No Connection
2	No Connection
3	Ground
4	Serial Out (to DB-9 Pin 2)
5	Serial In (to DB-9 Pin 3)

Appendix F: Automated Calibration

Calibration of the Hyper-bb is facilitated by an automated calibration tank, sold as an accessory to the Hyper-bb instrument.

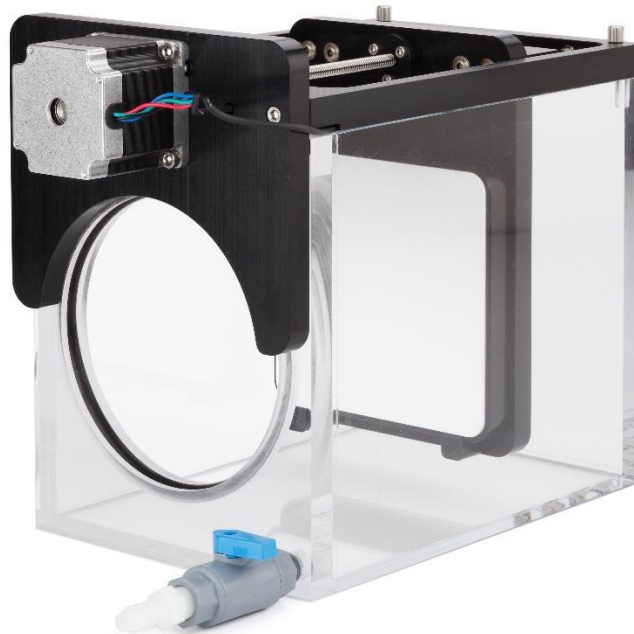

The calibration tank contains a 99% reflectance Spectralon plaque attached to a stepper a motor. The motor is used to precisely control the plaque position in the tank. The Hyper-bb instrument is inserted into the front of the tank, forming a watertight seal.

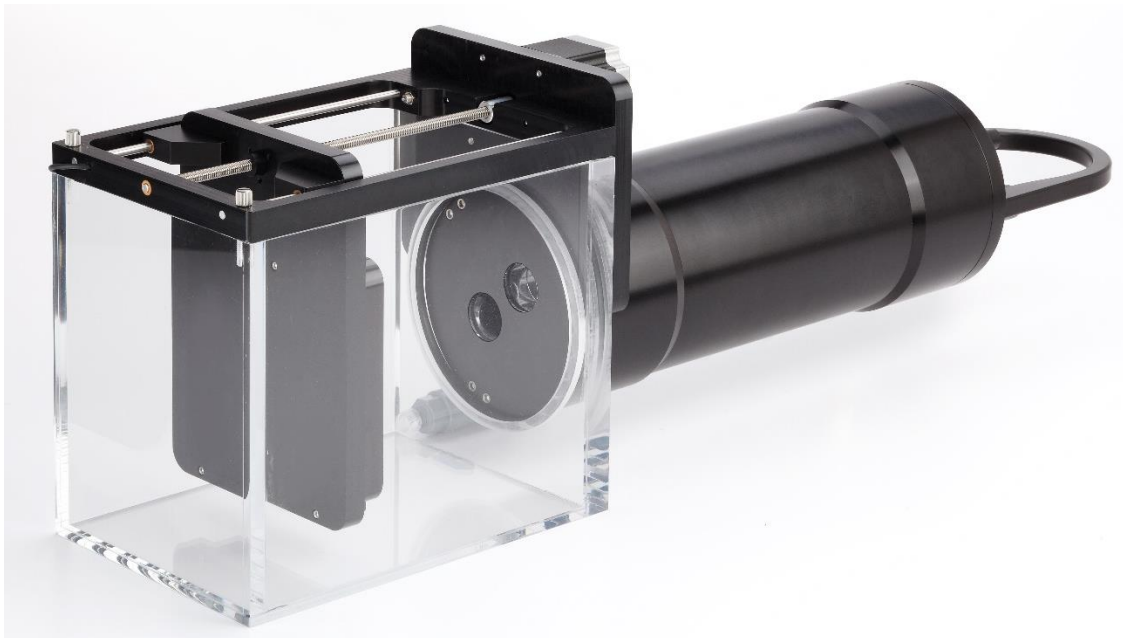

The procedure for conducting a calibration using the calibration tank is outlined below.

Setup

Remove the Spectralon plaque sled assembly from the calibration tank by unscrewing the two thumb screws and lifting the sled off the tank. Insert the Hyper-bb instrument into the front of the calibration tank. If installing the instrument in the tank is difficult, apply a thin coat of grease to the o-ring.

Fill the calibration tank with filtered, degassed water. Filling from the 'drain' at the bottom of the tank is recommended (as oppose to pouring water in from the top), as this will greatly reduce bubble formation. Fill the tank until the water just covers the top of the endcap of the Hyper-bb.

The Spectralon plaque should be coated with a layer of dilute Photo-Flow solution before the plaque is inserted into the water. We've found the best applicator is a spray bottle. The Photo-Flo solution is necessary to prevent bubble formation on the surface of the plaque. After applying the Photo-Flo solution, insert the plaque into the water and re-tighten the thumb screws that attach the sled to the tank. If bubbles are observed on the Spectralon plaque, remove the plaque from the water and apply more of the Photo-Flo solution.

Apply power to both the Hyper-bb and the calibration tank using the provided power cables. Both require 12 volts for typical operation. Connect the USB cables from the Hyper-bb and the calibration tank to a computer.

Calibration

The Hyper-bb software can perform an automated calibration by communicating with both the instrument and calibration tank. Open the Hyper-bb software and navigate to the calibration page. The software will automatically connect to the Hyper-bb when it is opened. Upon opening the Calibration tab, the software will search for the Hyper-bb calibration tank. Once the tank is detected, it will indicate that tank is connected in the upper right corner.

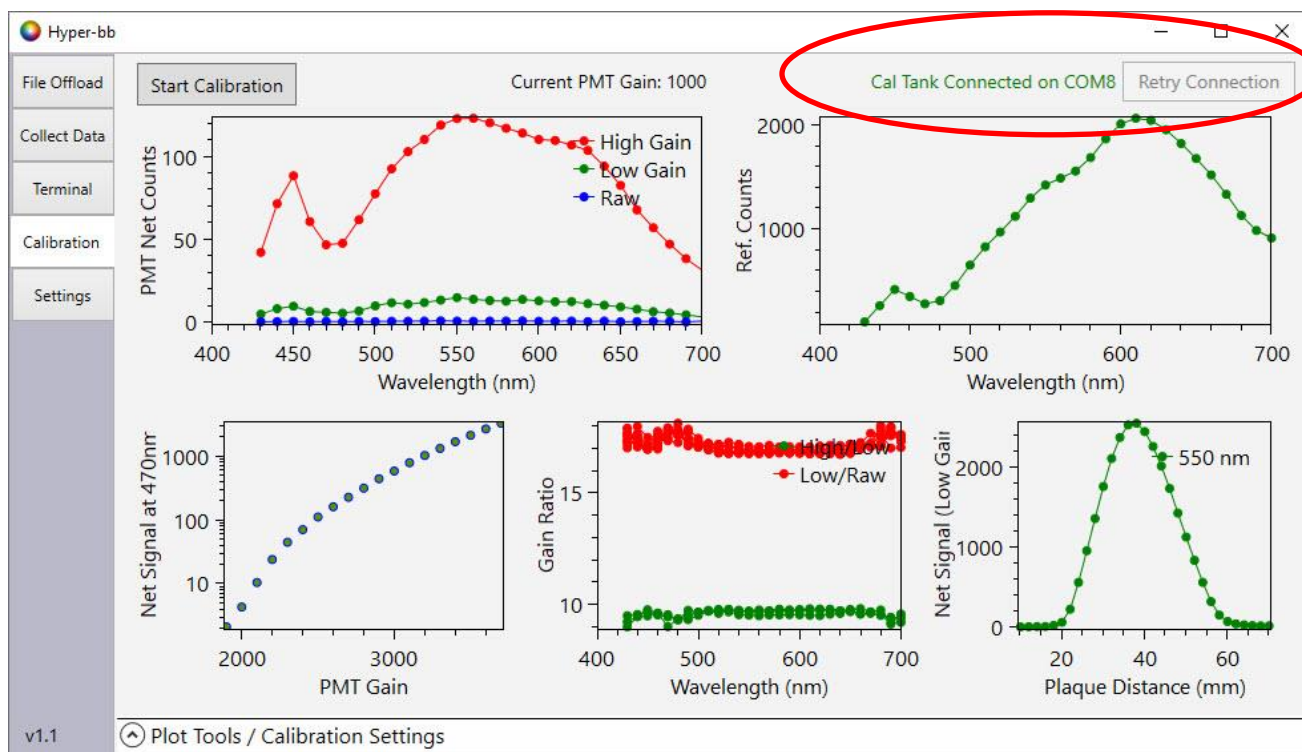

Plot controls and calibration settings can be accessed by expanding the panel at the bottom of the screen

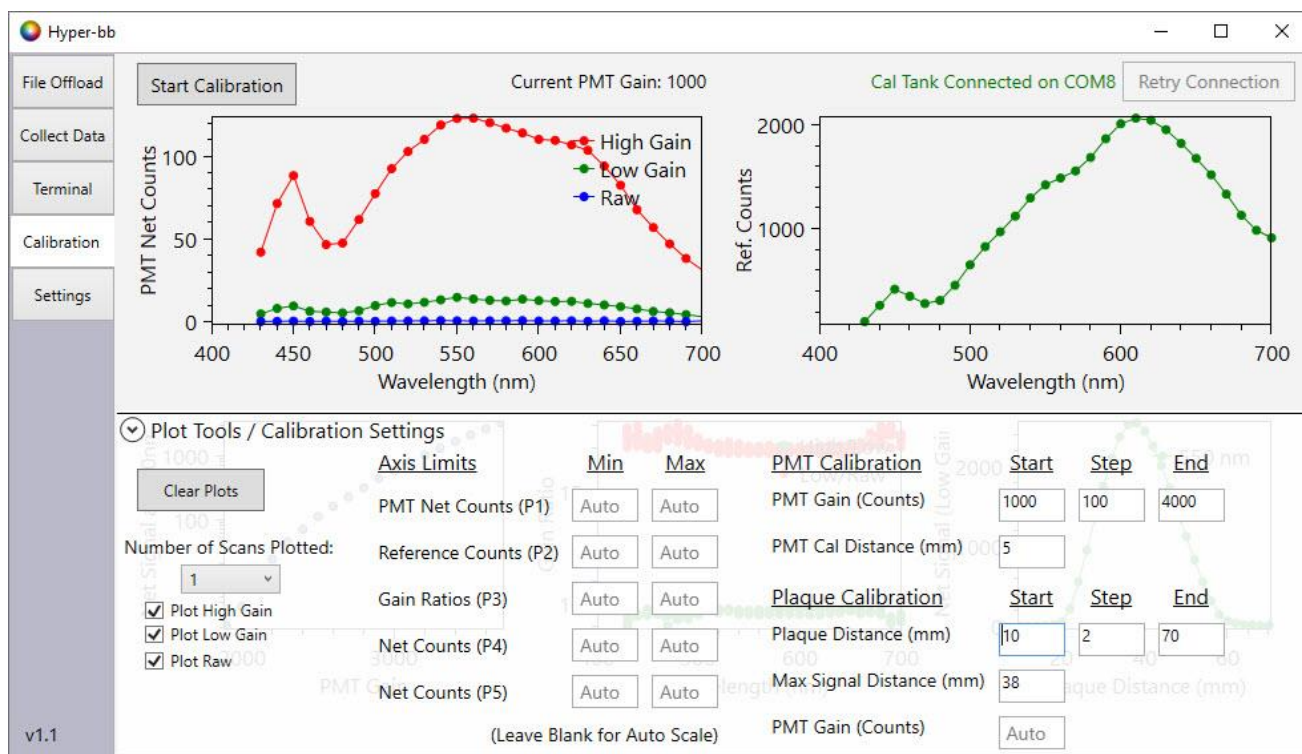

It is recommended to leave the calibration settings at their default values. Contact Sequoia Scientific for a complete explanation of these parameters.

Press the 'Start Calibration' button to start the calibration process. The calibration process starts by conducting a PMT calibration. The plaque will move to a position very close to the sensor face. The Hyper-bb will begin collecting a series of measurements. It will step through a range of PMT gain values and measure the signal levels at each gain. The relationship between signal level and PMT gain will be plotted in the lower left plot.

Next the plaque will move to the maximum signal distance and perform another series of measurements. This is used to determine the correct PMT gain value for the plaque calibration. Next, a plaque calibration will be performed where the plaque is moved away from the sensor face in small increments, with a measurement collected at each distance. The signal level vs. distance is plotted in the lower right plot. The ratio between sensor's analog gain channels is plotted in the lower middle plot.

When the calibration is finished, the software will display the names of the two calibration files that were just collected.

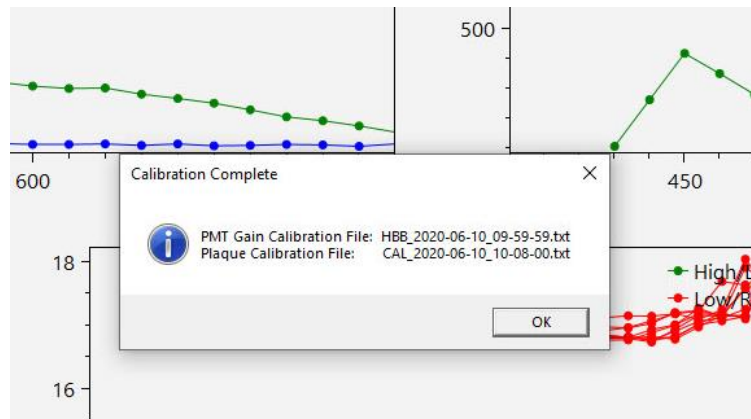

Make a note of the calibration file names. The calibration files can be offloaded from the instrument on the 'File Offload' tab. These calibration files can then be used to generate a new calibration .mat file using the MATLAB function `Hbb_ReadCal`. However, the `Hbb_ReadCal` function also requires a dark offset calibration file to generate a complete calibration file. See the next section on how to collect a dark offset calibration file.

Collecting a Dark Offset Calibration File

As part of the calibration procedure, it's required to collect a dark offset calibration file. This is a file that is collected with the received window total covered from incident light. This data is used to account for any bias in the electronics or optical sensors. To collect a dark offset file:

1. Make sure the wavelength range is set to 430-700nm with a step size of 10nm
2. Place black tape (electrical tape works well) over the receive window, so no light can enter the window.

3. Let the instrument warm up for 10 minutes. Send the 'scan' command and let the instrument run for 10 minutes.
4. After the instrument is warmed up, collect a 'gainscan' measurements using the command: 'gainscan 800 4000 100 1' (this will step from gain level 800 to 4000 in increments of 100, collecting a data record at each gain).
5. Once the instrument stops, offload the data file.

Save this data file, as it will be needed to generate a new calibration file using the MATLAB function Hbb_ReadCal.

Revision History

Version 1.22 June 2021	Minor corrections to instrument commands
Version 1.21 May 2021	Update Sequoia telephone number; editing and formatting; remove warranty statement (available at www.sequoiasci.com/support/warranty)
Version 1.2 November 2020	Editing
Version 1.1	Updated instrument photos Added Appendix F: Automated Calibration Switched connector endcap photos and pinouts
Version 1.0	Original version